

# Kućište elektroničke kutije

---

**Tomić, Davor**

**Supplement / Prilog**

*Publication year / Godina izdavanja:* **2015**

*Permanent link / Trajna poveznica:* <https://urn.nsk.hr/urn:nbn:hr:128:723506>

*Rights / Prava:* [In copyright](#) / [Zaštićeno autorskim pravom.](#)

*Download date / Datum preuzimanja:* **2025-02-07**



**VELEUČILIŠTE U KARLOVCU**  
Karlovac University of Applied Sciences

*Repository / Repozitorij:*

[Repository of Karlovac University of Applied  
Sciences - Institutional Repository](#)

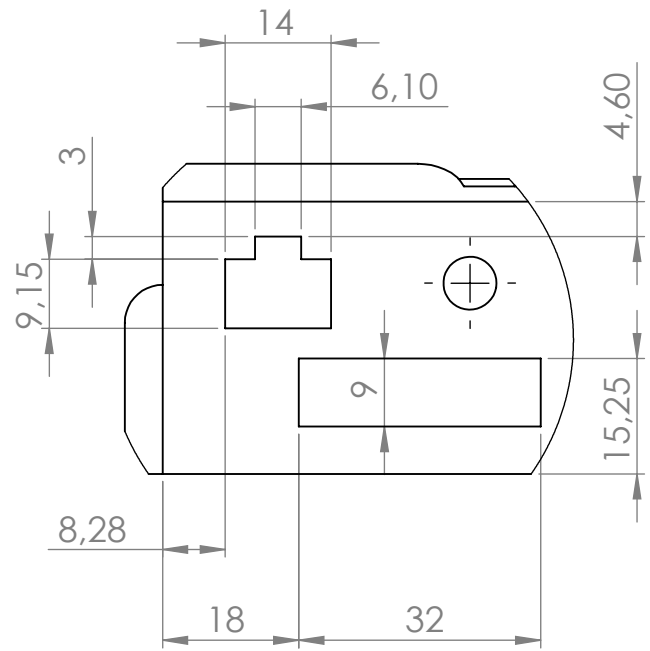
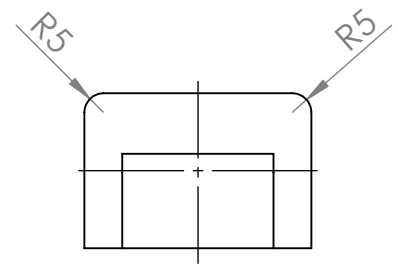
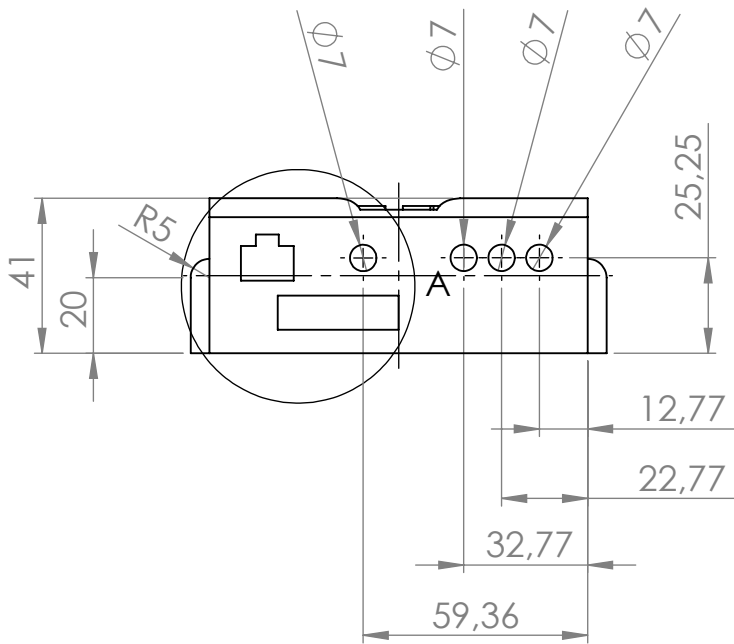

DETALJ A  
MJERILO 1 : 1

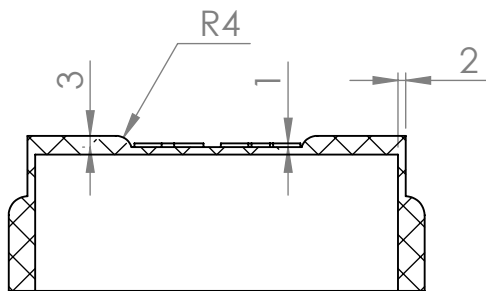
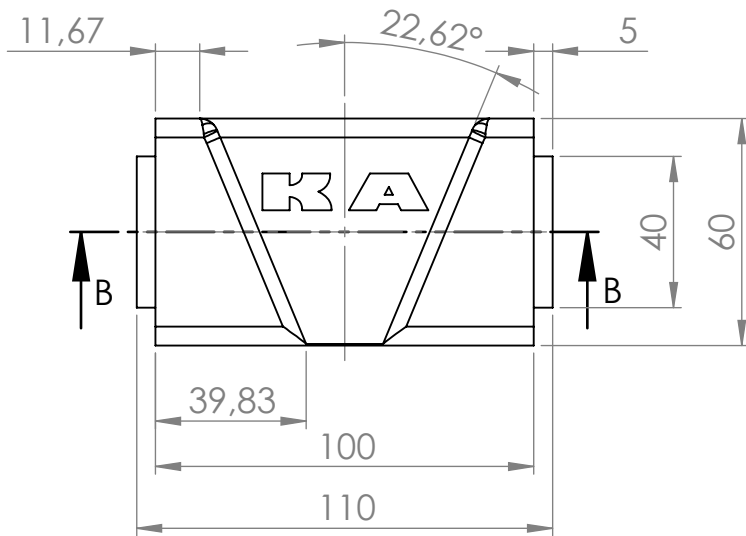

PRESJEK B-B

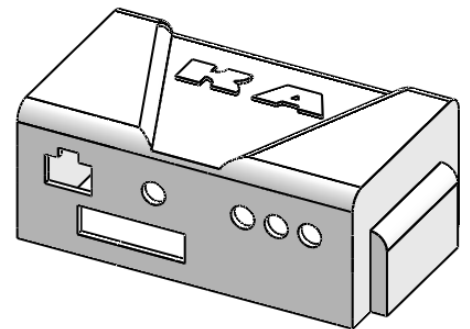

				NAZIV PROIZVODA	
				Kućište elektroničke kutije	
				NAZIV POZICIJE	
				Kutija ver8	
				A4	
IME	POTPIS	DATUM			
NACRTAO	DAVOR TOMIĆ	15.8.2015.			
PROVJERIO					
ODOBRIO					
			MATERIJAL:		
			ABS i PLA		
			MASA: 53 grama		
			MJERILO:1:2		LIST 1 OD 1