

Teleskopske tribine sklopljene; Zaštitna ograda; Nosač

Matija, Željko

Supplement / Prilog

Publication year / Godina izdavanja: **2015**

Permanent link / Trajna poveznica: <https://urn.nsk.hr/urn:nbn:hr:128:816117>

Rights / Prava: [In copyright](#) / [Zaštićeno autorskim pravom](#).

Download date / Datum preuzimanja: **2024-07-20**



VELEUČILIŠTE U KARLOVCU
Karlovac University of Applied Sciences

Repository / Repozitorij:

[Repository of Karlovac University of Applied Sciences - Institutional Repository](#)

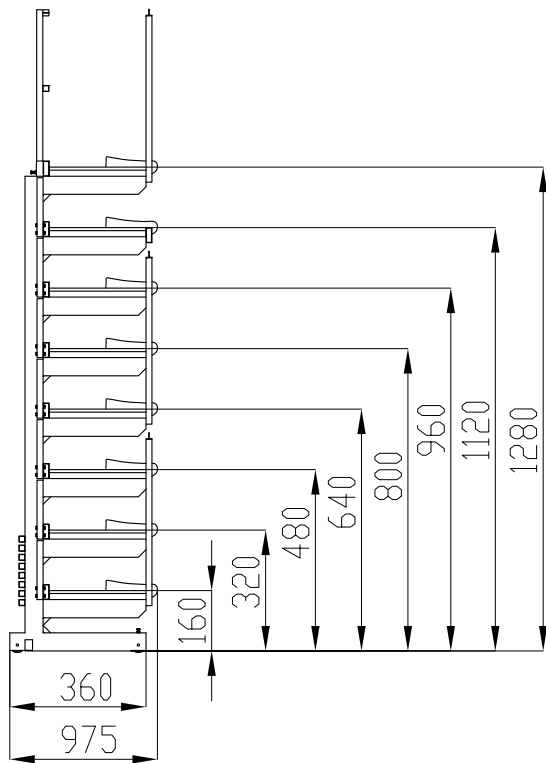
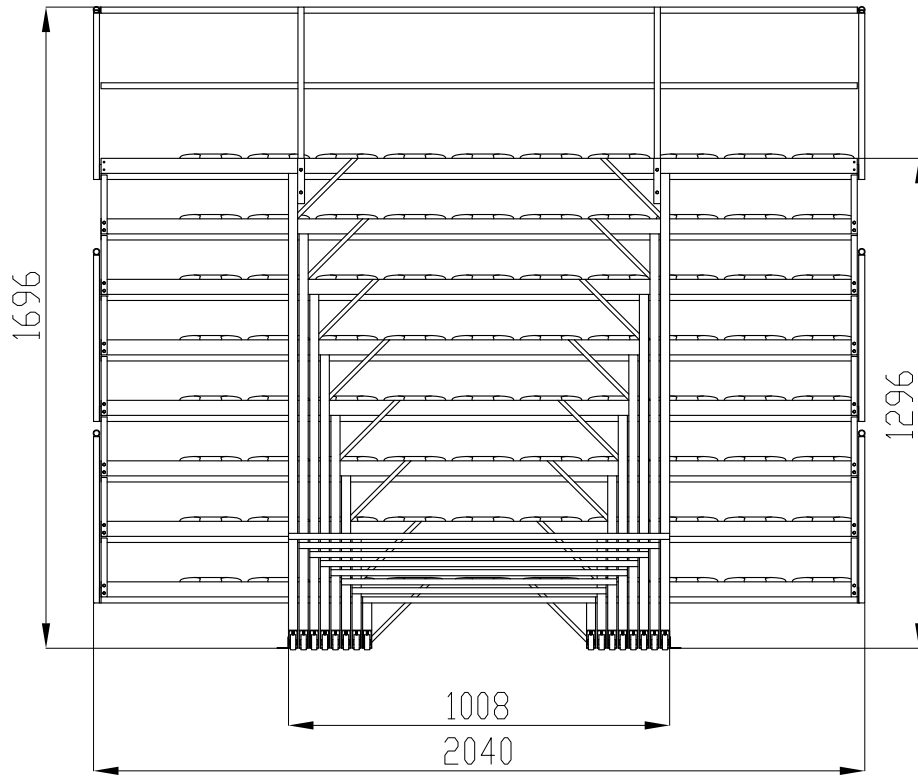

Broj naziva - code							
ISO - TOL							
	Poz.	Naziv dijela	Kom	Norma	Crtež br.	Materijal	Dimenzije Masa
	Napomena :						
		Datum	Ime i prezime	Potpis	VUKA - Karlovac		
	Konstruir.	09/2015.	Željko Matija				
	Crtao	09/2015.	Željko Matija				
	Odobrio						
	Mjerilo:	Naziv:				Masa:	List:
	M1:50	Teleskopske tribine sklopnjene					Ukupno:

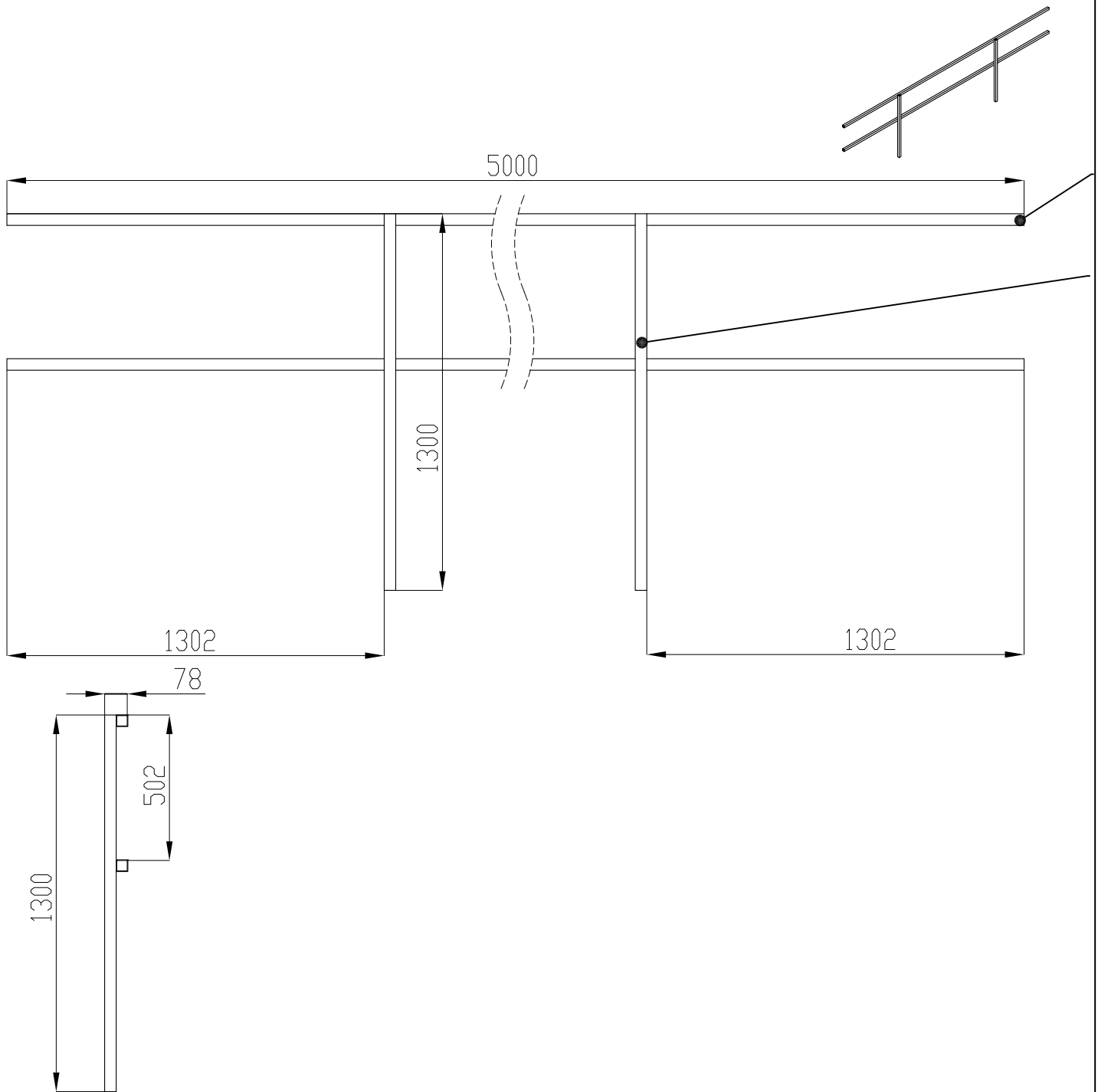

Broj naziva - code							
	2	Čelični profil	2		S235JRG1	40x40x1300	
ISO - TOL	1	Čelični profil	2		S235JRG1	40x40x5000	
		Poz. Naziv dijela	Kom	Norma	Crtež br.	Materijal	Dimenzije Masa
		Napomena : Svi spojevi čeličnih profila su zavareni a=3mm					
		Datum	Ime i prezime	Potpis	VUKA - Karlovac		
		Konstruir.	09/2015.	Željko Matija			
		Crtao	09/2015.	Željko Matija			
		Odobrio					
		Mjerilo:	Naziv:		Masa:	List:	
		M1:20	Zaštitna ograda			Ukupno:	

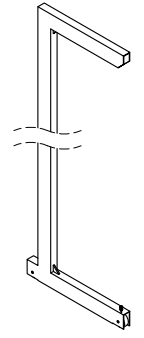
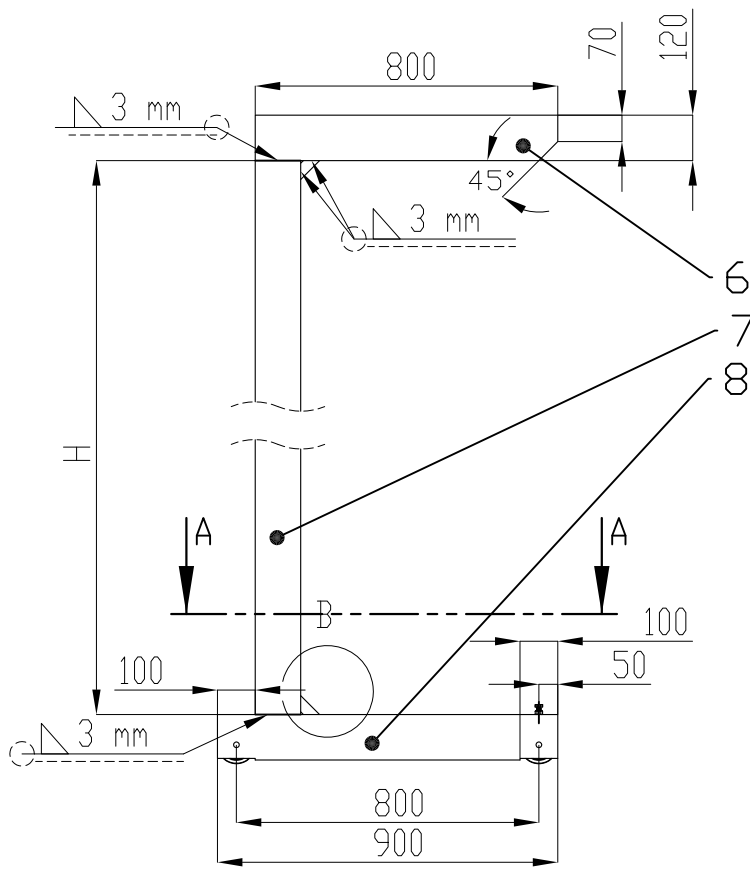

Presjek C-C
Mjerilo 1 : 2

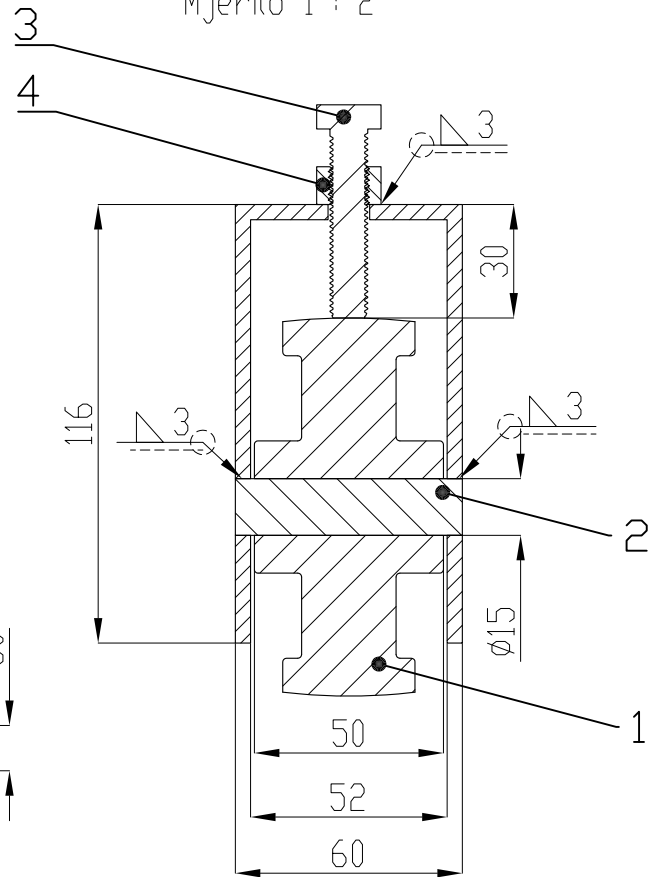

Detalj C-C
Mjerilo M1 : 2

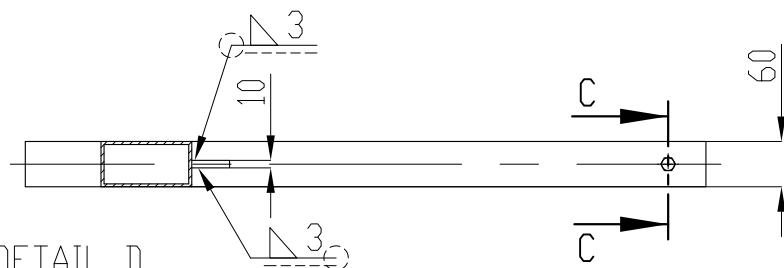

DETAIL D
SCALE 1 : 5

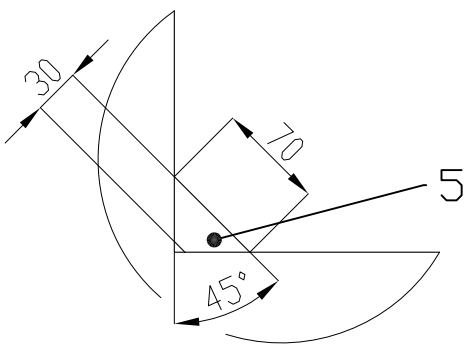

Dimenzija H mjenja se prema broju nosača:

- 1 - H=100 mm
- 2 - H=500 mm
- 3 - H=900 mm
- 4 - H=1300 mm
- 5 - H=1700 mm
- 6 - H=2100 mm
- 7 - H=2500 mm
- 8 - H=2900 mm

Ostale kote ostaju iste!

8	Čelični profil			S235JRG1	120x60x900	
7	Čelični profil	1		S235JRG1	120x60	
6	Čelični profil	1		S235JRG1	120x60x800	
5	Kutno ojačanje	2		S235JRG1	70x30 45°	
4	Matica	1			M10	
3	Vijak	1			M10x50	
2	Osovina kotača	2		S235JRG1	Ø15x40	
1	Sinkro kotač 100x35-DDS	2			100x35x15	
	Poz. Naziv dijela	Kom	Norma	Crtež br.	Materijal	Dimenzije Masa

Napomena : Svi spojevi čeličnih profila zavareni a=3mm

	Datum	Ime i prezime	Potpis
Konstruir.	09/2015.	Željko Matija	
Crtao	09/2015.	Željko Matija	
Odobrio			
Mjerilo:	Naziv:		Masa:
M1:20	Nosač		List: Ukupno:

VUKA - Karlovac