

Kućište elektroničke kutije

Tomić, Davor

Supplement / Prilog

Publication year / Godina izdavanja: **2015**

Permanent link / Trajna poveznica: <https://urn.nsk.hr/urn:nbn:hr:128:723506>

Rights / Prava: [In copyright](#) / [Zaštićeno autorskim pravom.](#)

Download date / Datum preuzimanja: **2024-11-29**



VELEUČILIŠTE U KARLOVCU
Karlovac University of Applied Sciences

Repository / Repozitorij:

[Repository of Karlovac University of Applied
Sciences - Institutional Repository](#)

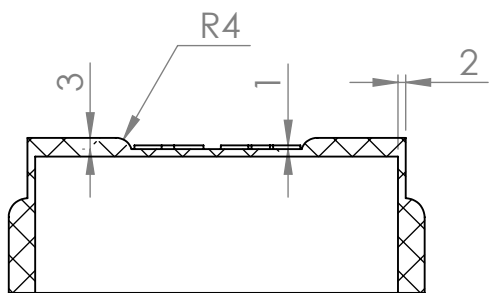
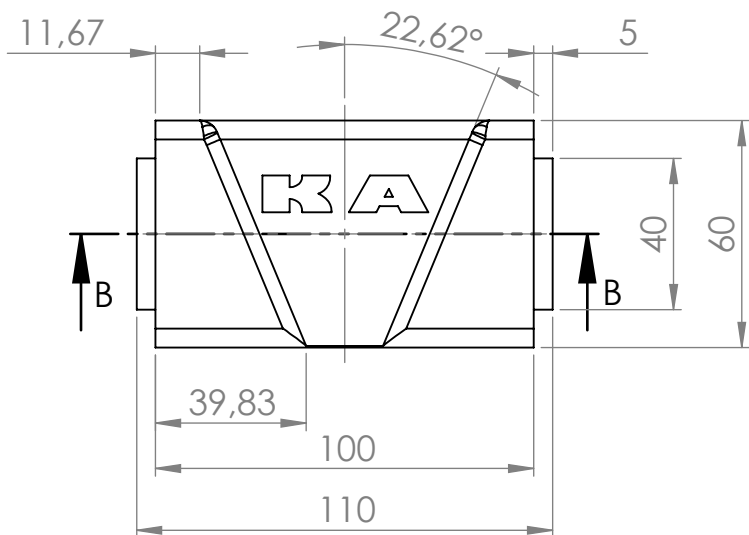
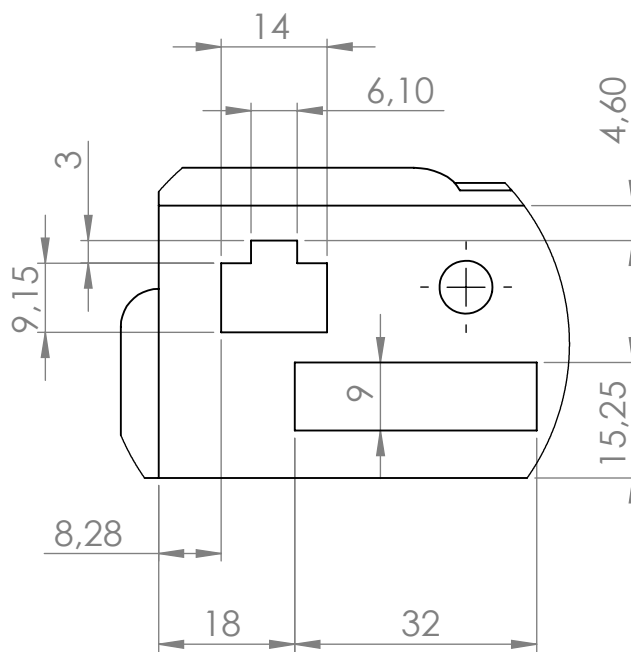
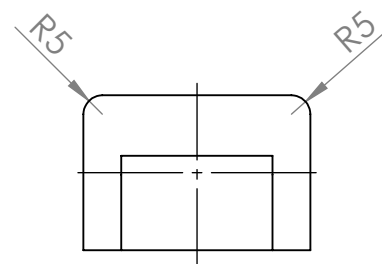
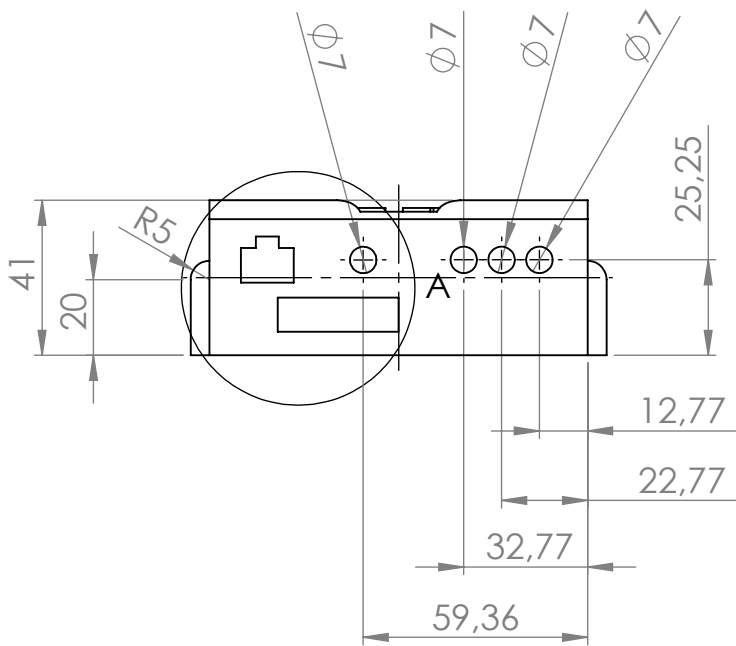

PRESJEK B-B

DETALJ A
MJERILO 1 : 1

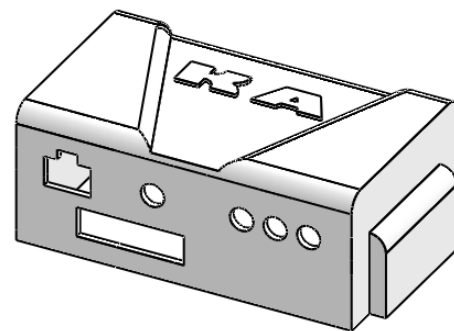

				NAZIV PROIZVODA	
				Kućište elektroničke kutije	
				NAZIV POZICIJE	
				Kutija ver8	
				A4	
IME	POTPIS	DATUM			
NACRTAO	DAVOR TOMIĆ	15.8.2015.			
PROVJERIO					
ODOBRIO					
			MATERIJAL:		
			ABS i PLA		
			MASA: 53 grama		
			MJERILO:1:2		LIST 1 OD 1